

# ATELIER ARETI

## PRODUCT

Alouette 004  
Floor light / 1 Bird

## MATERIALS AND COLOUR OPTIONS

Powder coated metal

## VERSIONS

Black structure (white reflector) 004OL-F01-ME01  
White structure (white reflector) 004OL-F01-ME02  
Colour structure (white reflector) 004OL-F01-ME03  
Black structure (brass reflector) 004OL-F01-ME04  
White structure (brass reflector) 004OL-F01-ME05  
Colour structure (brass reflector) 004OL-F01-ME06

## TECHNICAL DETAILS

1 x G9 LED 5W max  
110-230V  
IP20  
Light bulb not included

## WEIGHT

9 kg

## CABLE LENGTH

2,00 m

## NOTE

Mirrored bulbs reflect a lot of heat back to the lamp holder. Depending on the space around the lamp holder, the heat might build up above the recommended temperature, especially if the heat is trapped when moving upwards. For this reason, the max. wattage indicated does not apply to mirrored bulbs, but to non mirrored bulbs only. If mirrored bulbs are desired, only those with a low wattage (such as LEDs) should be used. The max. wattage for mirrored bulbs is 5 watt LED (equivalent of 40 watt traditional bulb)

## MADE IN

Germany

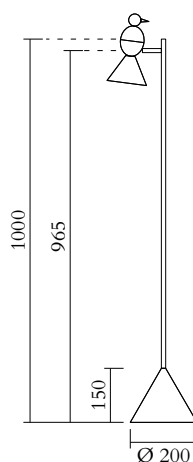

Sizes in mm. Flat attachments available only under request. Variations in colour and size are available for some collections, please contact Areti for more details.

Our collections are hand made and made to order, small irregularities in shape or surface will occur, they are inherent to the hand made process and should not be seen as flaws. For detailed information on any products: [contact@atelierareti.com](mailto:contact@atelierareti.com)

# ATELIER ARETI

## PRODUCT

Alouette 004  
Floor light / 2 Birds

## MATERIALS AND COLOUR OPTIONS

Powder coated metal

## VERSIONS

Black structure (white reflector) 004OL-F02-ME01  
White structure (white reflector) 004OL-F02-ME02  
Colour structure (white reflector) 004OL-F02-ME03  
Black structure (brass reflector) 004OL-F02-ME04  
White structure (brass reflector) 004OL-F02-ME05  
Colour structure (brass reflector) 004OL-F02-ME06

## TECHNICAL DETAILS

2 x G9 LED 5W max  
110-230V  
IP20  
Light bulbs not included

## WEIGHT

10 kg

## CABLE LENGTH

2,00 m

## NOTE

Mirrored bulbs reflect a lot of heat back to the lamp holder. Depending on the space around the lamp holder, the heat might build up above the recommended temperature, especially if the heat is trapped when moving upwards. For this reason, the max. wattage indicated does not apply to mirrored bulbs, but to non mirrored bulbs only. If mirrored bulbs are desired, only those with a low wattage (such as LEDs) should be used. The max. wattage for mirrored bulbs is 5 watt LED (equivalent of 40 watt traditional bulb)

## MADE IN

Germany

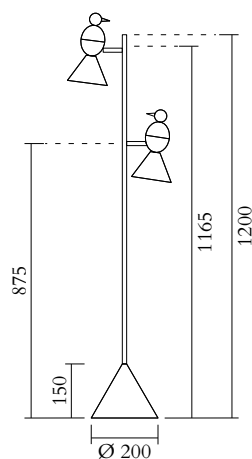

Sizes in mm. Flat attachments available only under request. Variations in colour and size are available for some collections, please contact Areti for more details.

Our collections are hand made and made to order, small irregularities in shape or surface will occur, they are inherent to the hand made process and should not be seen as flaws. For detailed information on any products: [contact@atelierareti.com](mailto:contact@atelierareti.com)

# ATELIER ARETI

## PRODUCT

Alouette 004  
Floor light / 3 Birds

## MATERIALS AND COLOUR OPTIONS

Powder coated metal

## VERSIONS

Black structure (white reflector) 004OL-F03-ME01  
White structure (white reflector) 004OL-F03-ME02  
Colour structure (white reflector) 004OL-F03-ME03  
Black structure (brass reflector) 004OL-F03-ME04  
White structure (brass reflector) 004OL-F03-ME05  
Colour structure (brass reflector) 004OL-F03-ME06

## TECHNICAL DETAILS

3 x G9 LED 5W max  
110-230V  
IP20  
Light bulbs not included

## WEIGHT

12 kg

## CABLE LENGTH

2,00 m

## NOTE

Mirrored bulbs reflect a lot of heat back to the lamp holder. Depending on the space around the lamp holder, the heat might build up above the recommended temperature, especially if the heat is trapped when moving upwards. For this reason, the max. wattage indicated does not apply to mirrored bulbs, but to non mirrored bulbs only. If mirrored bulbs are desired, only those with a low wattage (such as LEDs) should be used. The max. wattage for mirrored bulbs is 5 watt LED (equivalent of 40 watt traditional bulb)

## MADE IN

Germany

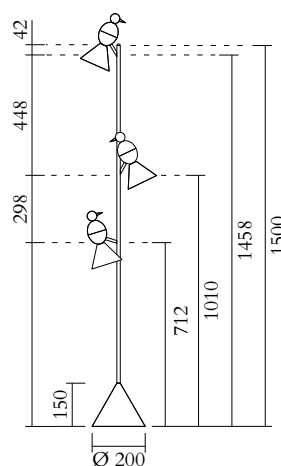

Sizes in mm. Flat attachments available only under request. Variations in colour and size are available for some collections, please contact Areti for more details.

Our collections are hand made and made to order, small irregularities in shape or surface will occur, they are inherent to the hand made process and should not be seen as flaws. For detailed information on any products: [contact@atelierareti.com](mailto:contact@atelierareti.com)

# ATELIER ARETI

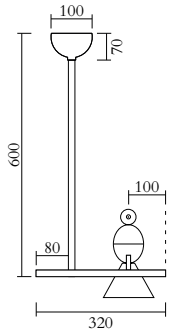

Alouette Pendant 1 Bird 'T'  
004OL-C01

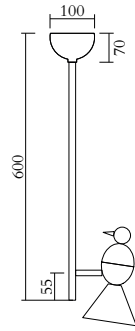

Alouette Pendant 1 Bird 'I'  
004OL-C02

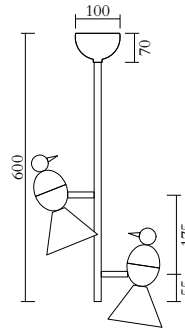

Alouette Pendant 2 Birds 'I'  
004OL-C03

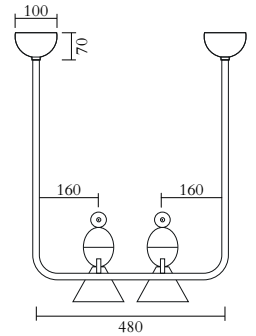

Alouette Pendant 2 Birds 'U'  
004OL-C04

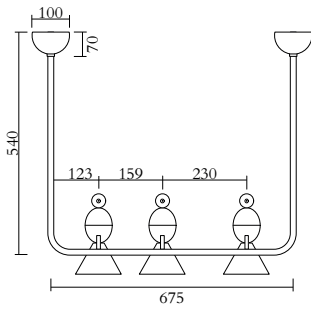

Alouette Pendant 3 Birds 'U'  
004OL-C05

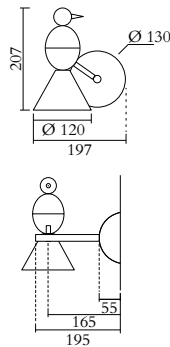

Alouette Wall  
004OL-W01

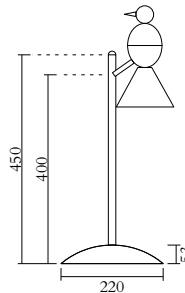

Alouette Desk / straight  
004OL-D01

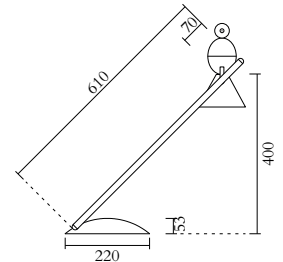

Alouette Desk / slanted  
004OL-D02

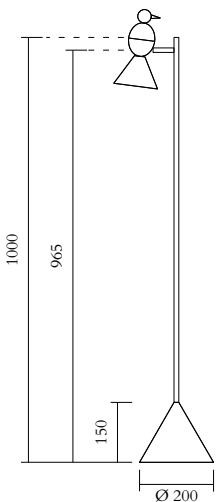

Alouette Floor 1 bird  
004OL-F01

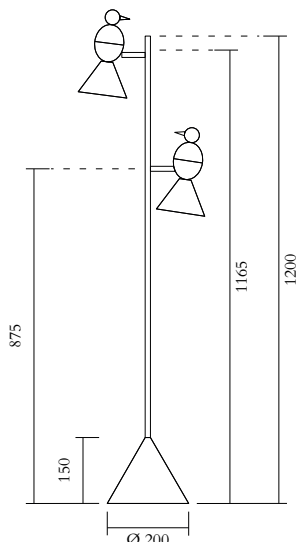

Alouette Floor 2 birds  
004OL-F02

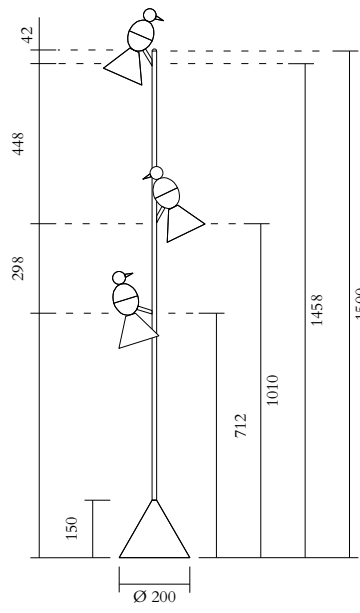

Alouette Floor 3 birds  
004OL-F03

