

ATELIER ARETI

PRODUCT

Solid tables 225
Low table / Cylinder

MATERIALS AND COLOUR OPTIONS

Solid oiled oak; marble

VERSIONS

Marble
225OF-T01-MA01
Oiled solid oak with end grain top
225OF-T01-WO01

WEIGHT

Marble: 65 kg

MADE IN

Italy + Slovenia

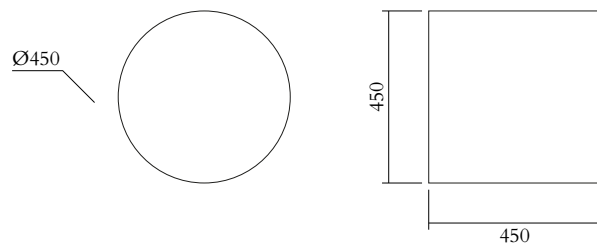

Sizes in mm. Variations in colour and size are available for some collections, please contact Areti for more details.

Our collections are hand made and made to order, small irregularities in shape or surface will occur, they are inherent to the hand made process and should not be seen as flaws. For detailed information on any products: contact@atelierareti.com

ATELIER ARETI

PRODUCT

Solid tables 225

Low table / Cylinder with cut round

MATERIALS AND COLOUR OPTIONS

Solid oiled oak; marble

VERSIONS

Marble

225OF-T02-MA01

Oiled solid oak with end grain top

225OF-T02-WO01

WEIGHT

Marble: 65 kg

MADE IN

Italy + Slovenia

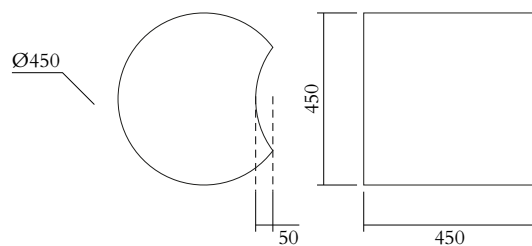

Sizes in mm. Variations in colour and size are available for some collections, please contact Areti for more details.

Our collections are hand made and made to order, small irregularities in shape or surface will occur, they are inherent to the hand made process and should not be seen as flaws. For detailed information on any products: contact@atelierareti.com

ATELIER ARETI

PRODUCT

Solid tables 225

Low table / Cylinder with a quarter cut

MATERIALS AND COLOUR OPTIONS

Solid oiled oak; marble

VERSIONS

Marble

225OF-T03-MA01

Oiled solid oak with end grain top

225OF-T03-WO01

WEIGHT

Marble: 65 kg

MADE IN

Italy + Slovenia

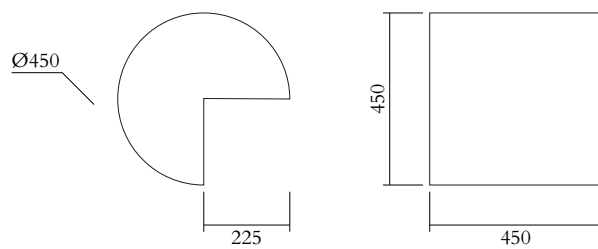

Sizes in mm. Variations in colour and size are available for some collections, please contact Areti for more details.

Our collections are hand made and made to order, small irregularities in shape or surface will occur, they are inherent to the hand made process and should not be seen as flaws. For detailed information on any products: contact@atelierareti.com

ATELIER ARETI

PRODUCT

Solid tables 225
Low table / Half cylinder

MATERIALS AND COLOUR OPTIONS

Solid oiled oak; marble

VERSIONS

Marble
225OF-T04-MA01
Oiled solid oak with end grain top
225OF-T04-WO01

WEIGHT

Marble: 80 kg

MADE IN

Italy + Slovenia

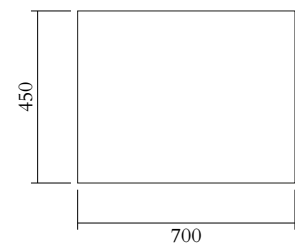
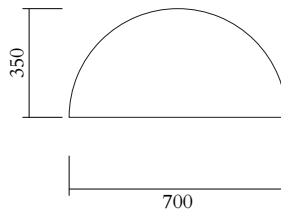

Sizes in mm. Variations in colour and size are available for some collections, please contact Areti for more details.

Our collections are hand made and made to order, small irregularities in shape or surface will occur, they are inherent to the hand made process and should not be seen as flaws. For detailed information on any products: contact@atelierareti.com

ATELIER ARETI

PRODUCT

Solid tables 225
Low table / Triangle

MATERIALS AND COLOUR OPTIONS

Solid oiled oak; marble

VERSIONS

Marble
225OF-T05-MA01
Oiled solid oak with end grain top
225OF-T05-WO01

WEIGHT

Marble: 82 kg

MADE IN

Italy + Slovenia

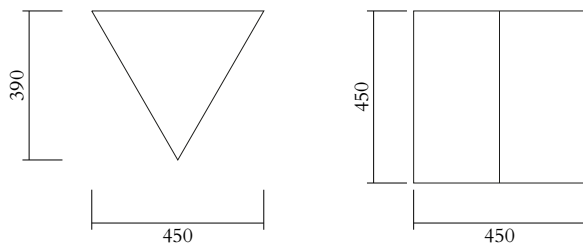

Sizes in mm. Variations in colour and size are available for some collections, please contact Areti for more details.

Our collections are hand made and made to order, small irregularities in shape or surface will occur, they are inherent to the hand made process and should not be seen as flaws. For detailed information on any products: contact@atelierareti.com

ATELIER ARETI

PRODUCT

Solid tables 225
Low table / Cube

MATERIALS AND COLOUR OPTIONS

Solid oiled oak; marble

VERSIONS

Marble

225OF-T06-MA01

Oiled solid oak with end grain top

225OF-T06-WO01

WEIGHT

Marble: 81 kg

MADE IN

Italy + Slovenia

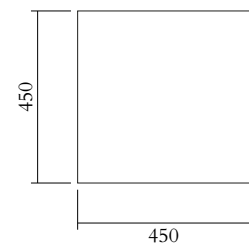
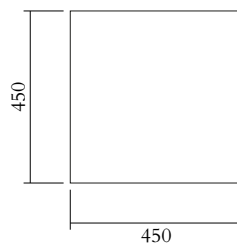

Sizes in mm. Variations in colour and size are available for some collections, please contact Areti for more details.

Our collections are hand made and made to order, small irregularities in shape or surface will occur, they are inherent to the hand made process and should not be seen as flaws. For detailed information on any products: contact@atelierareti.com

ATELIER ARETI

PRODUCT

Solid tables 225

Low table / Cube with cut angle

MATERIALS AND COLOUR OPTIONS

Solid oiled oak; marble

VERSIONS

Marble

225OF-T07-MA01

Oiled solid oak with end grain top

225OF-T07-WO01

WEIGHT

Marble: 87 kg

MADE IN

Italy + Slovenia

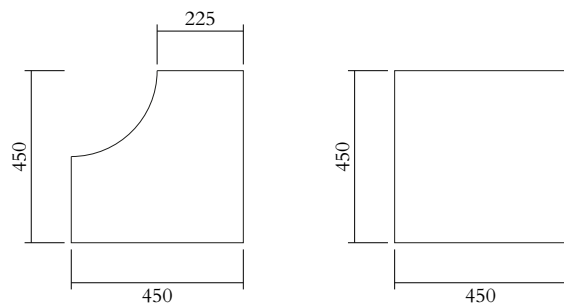

Sizes in mm. Variations in colour and size are available for some collections, please contact Areti for more details.

Our collections are hand made and made to order, small irregularities in shape or surface will occur, they are inherent to the hand made process and should not be seen as flaws. For detailed information on any products: contact@atelierareti.com